



" LESS IS MORE. "

AERO | 20W



Power Consumption	20W
Beam Angle	15/25/38°
Color Temperature	3000/4000/5000K
Luminous Flux	1300lm
CRI	≥90Ra
Dimension	W63xL144xH163mm
Housing Color	White/Black
Material	AL

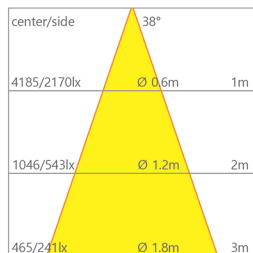
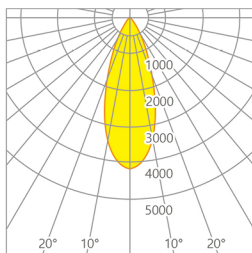
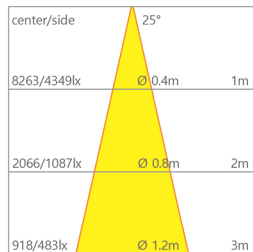
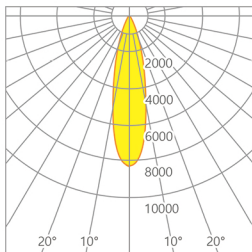
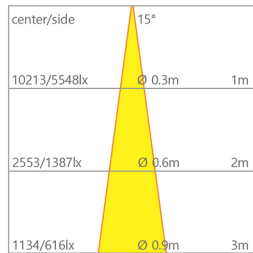
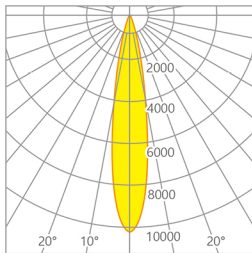
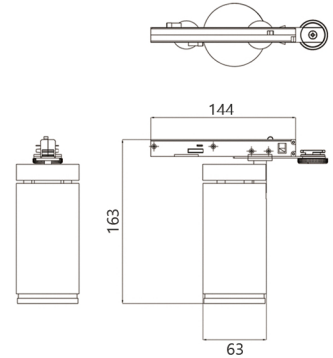

Model No.	Power Consumption	Luminous Flux	CRI	Color Temperature	Beam Angle	Housing Color
TRID20-W93015-ND	20W	1300lm	≥90Ra	3000K	15°	White
TRID20-B93015-ND	20W	1300lm	≥90Ra	3000K	15°	Black
TRID20-W94015-ND	20W	1300lm	≥90Ra	4000K	15°	White
TRID20-B94015-ND	20W	1300lm	≥90Ra	4000K	15°	Black
TRID20-W95015-ND	20W	1300lm	≥90Ra	5000K	15°	White
TRID20-B95015-ND	20W	1300lm	≥90Ra	5000K	15°	Black
TRID20-W93025-ND	20W	1300lm	≥90Ra	3000K	25°	White
TRID20-B93025-ND	20W	1300lm	≥90Ra	3000K	25°	Black
TRID20-W94025-ND	20W	1300lm	≥90Ra	4000K	25°	White
TRID20-B94025-ND	20W	1300lm	≥90Ra	4000K	25°	Black
TRID20-W95025-ND	20W	1300lm	≥90Ra	5000K	25°	White
TRID20-B95025-ND	20W	1300lm	≥90Ra	5000K	25°	Black
TRID20-W93038-ND	20W	1300lm	≥90Ra	3000K	38°	White
TRID20-B93038-ND	20W	1300lm	≥90Ra	3000K	38°	Black
TRID20-W94038-ND	20W	1300lm	≥90Ra	4000K	38°	White
TRID20-B94038-ND	20W	1300lm	≥90Ra	4000K	38°	Black
TRID20-W95038-ND	20W	1300lm	≥90Ra	5000K	38°	White
TRID20-B95038-ND	20W	1300lm	≥90Ra	5000K	38°	Black

AERO | 40W



Power Consumption	40W
Beam Angle	15/25/38°
Color Temperature	3000/4000/5000K
Luminous Flux	2600lm
CRI	≥90Ra
Dimension	W85xL144xH198mm
Housing Color	White/Black
Material	AL

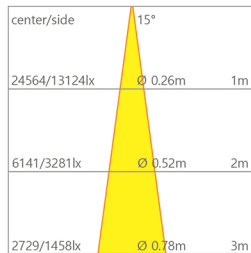
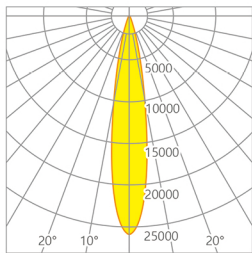
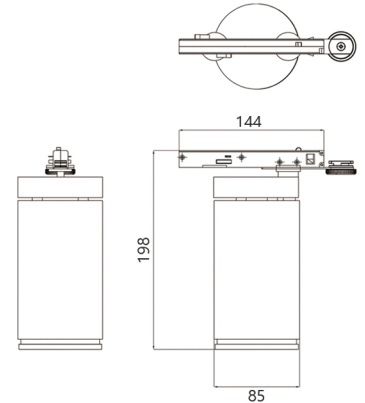

Model No.	Power Consumption	Luminous Flux	CRI	Color Temperature	Beam Angle	Housing Color
TRID40-W93015-ND	40W	2600lm	≥90Ra	3000K	15°	White
TRID40-B93015-ND	40W	2600lm	≥90Ra	3000K	15°	Black
TRID40-W94015-ND	40W	2600lm	≥90Ra	4000K	15°	White
TRID40-B94015-ND	40W	2600lm	≥90Ra	4000K	15°	Black
TRID40-W95015-ND	40W	2600lm	≥90Ra	5000K	15°	White
TRID40-B95015-ND	40W	2600lm	≥90Ra	5000K	15°	Black

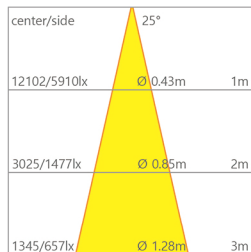
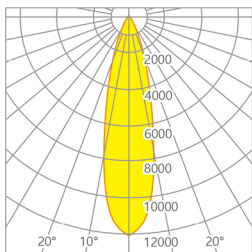

TRID40-W93025-ND	40W	2600lm	≥90Ra	3000K	25°	White
TRID40-B93025-ND	40W	2600lm	≥90Ra	3000K	25°	Black
TRID40-W94025-ND	40W	2600lm	≥90Ra	4000K	25°	White
TRID40-B94025-ND	40W	2600lm	≥90Ra	4000K	25°	Black
TRID40-W95025-ND	40W	2600lm	≥90Ra	5000K	25°	White
TRID40-B95025-ND	40W	2600lm	≥90Ra	5000K	25°	Black

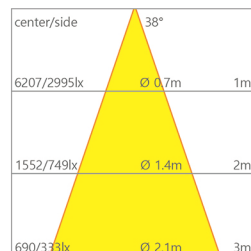
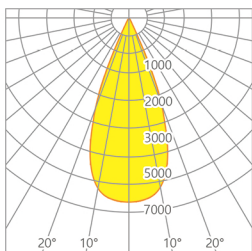

TRID40-W93038-ND	40W	2600lm	≥90Ra	3000K	38°	White
TRID40-B93038-ND	40W	2600lm	≥90Ra	3000K	38°	Black
TRID40-W94038-ND	40W	2600lm	≥90Ra	4000K	38°	White
TRID40-B94038-ND	40W	2600lm	≥90Ra	4000K	38°	Black
TRID40-W95038-ND	40W	2600lm	≥90Ra	5000K	38°	White
TRID40-B95038-ND	40W	2600lm	≥90Ra	5000K	38°	Black